

ABMESSUNGEN

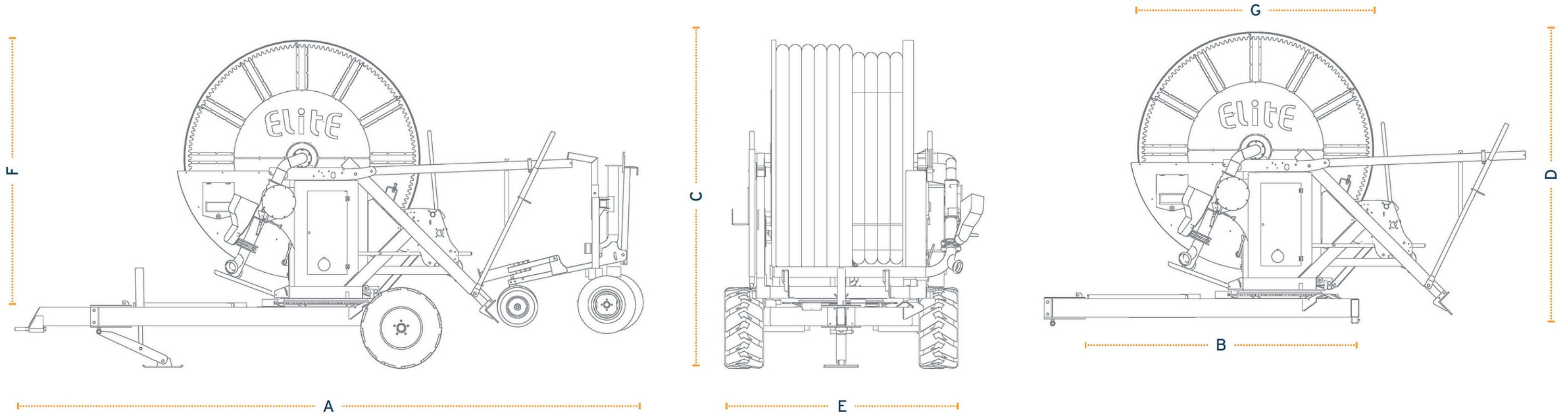

Modell	A (mm)	B (mm)	C (mm)	D (mm)	E (mm)	F (mm)	G (mm)	Gewicht mit Wagen (kg)
730	6600	4250	3670	3305	2825	2955	3240	4000
735	6600	4250	3810	3450	2825	3100	3240	4800